

1 SCANNER BRAND IS WORTH MORE THAN IT COSTS

World-leading SmartLF scanners
deliver just what you need for
large formats: value for money



COUNT ON COLORTRAC

COUNT ON COLORTRAC

Since 1989, Colortrac has made it easy and affordable to meet high scanning standards. Simply capture, enhance, share, copy and preserve vital information. No nonsense – just value you can count on.

INNOVATION COUNTS

Colortrac SmartLF scanners offer the technology and innovation you'd expect from a far more expensive scanning solution. Clever engineering is the secret. As is a commitment to quality.

We're pioneers. Consider our SingleSensor™ technology and SUREDRIVE powered soft roller system, for example. No other scanner offers similar innovations. Or can match the quality for the price.

QUALITY COUNTS

No matter what you're scanning or the type of scanning application, you can count on great quality images with Colortrac. Our R&D experts are masters of light with complete control of every scanning parameter.

Since 1989, our mission has been to make scanners and software that get the job done to high standards at a competitive price.



7

COLORTRAC INDUSTRY FIRSTS

YOUR NEEDS COUNT

Different industries use Colortrac scanners for different purposes.

Have thick documents? Scanning lots? On the move? Whether you work in construction and engineering, education, artwork and graphics, GIS and mapping, a copy shop or elsewhere, there's a Colortrac SmartLF solution to meet your large format scanning needs.

GREEN COUNTS

We work hard in big and small ways to continuously reduce our environmental footprint.

We have:

- Changed to using recyclable plastic as a raw material wherever possible
- Started consolidating more shipments to reduce wooden pallet use
- Improved our sea and rail shipping logistics to eliminate air freighting
- Reorganised factory production to save energy on lighting and air-conditioning
- Embraced a robust common parts, waste and stock-reduction regime

www.colortrac.com/green

1. SINGLESENSOR™

1st (and only) 1-piece, full-width color CIS solution. The most accurate, reliable solution for wide CIS devices. Optimal, affordable image quality

2. SUREDRIVE

1st single, powered soft-roller system for even media pressure and high-quality images. Assists instead of resists paper progress through the scanner

3. FIREFLY

1st large format scanner with SuperSpeed USB 3.0 for faster, more efficient data transfer

4. OPEN-APERTURE/GLASS-FREE

1st open-aperture, glass-free scanner for streak-free scans. Completely unaffected by dirt and dust

5. LED LIGHTING

1st CCD scanner to use LEDs for long life, low energy use and instant-on performance. Lifetime solution for low maintenance and optimal document illumination

6. 'SCAN-ONCE-EDIT'

1st in-program image editor known as 'scan-once-edit'. Eliminate pre-scan, reduce scan times, halve the number of document passes

7. THICK MEDIA SCANNING

1st thick-media large format scanner for even more business flexibility. Scan prints mounted on board or artwork directly printed onto board

3 SERIES 5 SIZES

ENDLESS POSSIBILITIES

NO NONSENSE

Choosing the right scanner shouldn't be difficult. That's why we also take a no-nonsense approach to the number of CIS and CCD scanners we offer.

Whether you need to scan hand-drawn originals, old plans, copies or printed construction site drawings that have been marked-up, you'll find a SmartLF scanner ideal for the task.

The Colortrac SmartLF range includes 3 series of hardworking scanners:

- **SmartLF SCi**
- **SmartLF SGi**
- **SmartLF Scan!**

Each comes in different sizes. All are ideal for capturing, sharing and copying large format information. They're especially well-suited to archiving and enhancement, too.

What's more, you can choose either a standalone floor stand or a repro stand for the scanner that fits above your printer. Either way you get a no-nonsense workstation.





SWITCH ON AND START SCANNING WITH CIS SINGLESENSOR™

Concerned about stories of calibration issues with CIS scanners? Worried about image quality? Want to simply turn your scanner on and start scanning?

Colortrac's patented SingleSensor™ technology is a key component of both the SmartLF SCi (the office workhorse) and the portable SmartLF Scan!

SingleSensor™ technology means that, unlike most CIS scanners, there's no need for sensor stitching. Just switch on and scan. It produces sharp, clean and accurate digital reproductions the first time. Every time.

Both the SmartLF SCi and the SmartLF Scan! are CIS scanners, ideal for scanning flat originals.

- PRESERVE 
- SHARE 
- ENHANCE 
- COPY 
- CAPTURE 

SWITCH ON AND START SCANNING WITH CCD

It's not only our CIS models that are ready to scan when you are. LED illumination ensures instant-on performance in Colortrac CCD scanners as well.

The Colortrac SmartLF SGi series scans both thin and thick originals beautifully. Documents that are fragile or have creased or textured surfaces scan optimally too.

You get ultra high-quality scans, thanks to the same CCD sensor technology used in professional quality cameras. And true-to-life dark and light tones make your images come alive. That's why the SmartLF SGi is ideal for photos, artwork and documents mounted on boards.

Count on the highest quality scans for all your document types. With the SmartLF SGi, reproductions are right the first time. Every time.

What are your needs?

Different industries use Colortrac scanners for different purposes. All Colortrac SmartLF scanners are ideal to capture, copy, enhance, preserve and share large format information digitally. See how these industries use our scanners.

CONSTRUCTION AND ENGINEERING

EDUCATION

ARTWORK AND GRAPHICS

GIS AND MAPS

COPY SHOP

CONSTRUCTION AND ENGINEERING



EDUCATION



ARTWORK AND GRAPHICS



GIS AND MAPS



COPY SHOP



WHY 1 TECHNOLOGY MAKES ALL THE DIFFERENCE IN THE WORLD

ABOUT SINGLESSENSOR™ TECHNOLOGY

Every Colortrac CIS scanner features patented SingleSensor™ technology. Most CIS scanners use staggered sensors that scan parts of the image at different times, then join the pieces back together on-the-fly. This process is fine when the original is flat and lightweight. But folded, creased or heavier than normal documents compromise its effectiveness.

Colortrac's unique SingleSensor™ technology uses a continuous line of sensors to collect information across the full width of the document in a single step. Sensors are 'stitched for life' at the factory and accurate to 1 pixel. The result is a scan that is almost totally unaffected by folds, bumps or document weight.

SingleSensor™ technology also means you never have to wait for your Colortrac scanner to be re-calibrated as part of a maintenance routine or after moving the scanner. No waiting. No nonsense.

1 LINE 50,400 SENSORS 144 LEDS

Colortrac CIS scanners contain up to 50,400 single image sensors in 1 straight line. They also have up to 144 LEDs, which eliminate shadows due to document folds or creases, save energy and last for decades. No warm-up time necessary.

You benefit from:

- High productivity
- Dependable accuracy
- Fast return on investment
- No maintenance except cleaning
- Excellent fold and crease tolerance
- Instant-on; no warm up, no waiting
- Minimal training
- Full-function software included
- High LED density eliminates shadowing
- 1200 dpi optical resolution;
9600 dpi max. scanning resolution

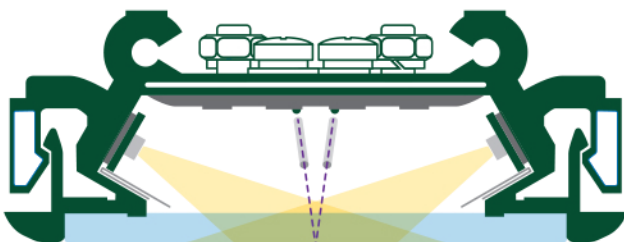

With SingleSensor™ technology, you get an uninterrupted scan line across the full width of the CIS scanner. No stitching or calibration required. The result: quality, convenient scanning.

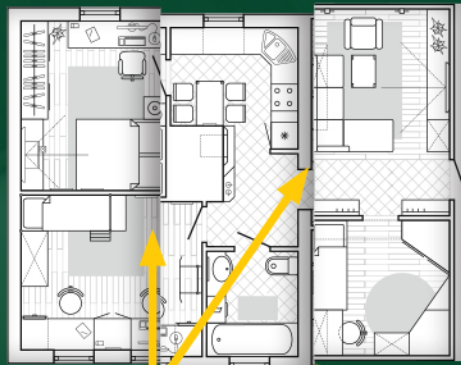

Shadows

Misalignment

Conventional, staggered sensors

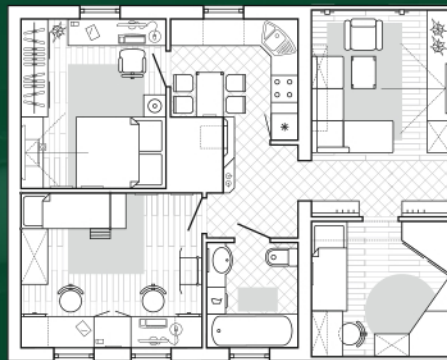

SingleSensor™

Since not all the data is captured at the same time with conventional, staggered sensors, variations in document speed and feed inconsistencies can produce uneven scans. And, electronic realignment doesn't always work at the folds and leading or trailing edges of a document.

SingleSensor™ technology solves the problem.

SmartLF SCi

The high-volume workhorse

Get the job done fast, with no stopping or waiting. The SmartLF SCi delivers high quality and speed for everyday scanning tasks.

- Perfect for engineering, construction, line drawings, maps and plans
- Vibrant color and excellent size accuracy
- Game-changing SingleSensor™ technology for large format image quality
- SUREDRIVE powered soft-roller system for even media pressure and high-quality images
- Designed for high volume
- Low maintenance
- SmartWorks TOUCH software is included
- For optional software choose from:
 - SmartWorks Imaging – new with remote control app for tablets (tablet not included)
 - SmartWorks Pro – support for older scanners
- Basic floor stand, PC mount kit and repro stand options



SENSOR	SCAN SIZE	OPTICAL DPI	MAX DPI	INSTANT ON	PAPER LOAD	REMOTE SOFTWARE CONTROL
Single Sensor™	36" 42"	1200	9600	YES	UP	Yes



IDEAL FOR THESE DOCUMENT TYPES

- TECHNICAL
- MAPS
- POSTERS
- PHOTOS

SUREDRIVE TECHNOLOGY

Ensure even media pressure for high-quality images. Single, powered soft-roller system assists paper progress through the scanner.



SUPERSPEED INTERFACE

Scan wider and at higher resolutions without decreasing productivity. SuperSpeed USB 3.0 ensures fast, efficient data transfer.



CLEARVIEW TECHNOLOGY

With ClearView up to 144 LEDs make sure every piece of information on your document is accurately imaged and recorded.

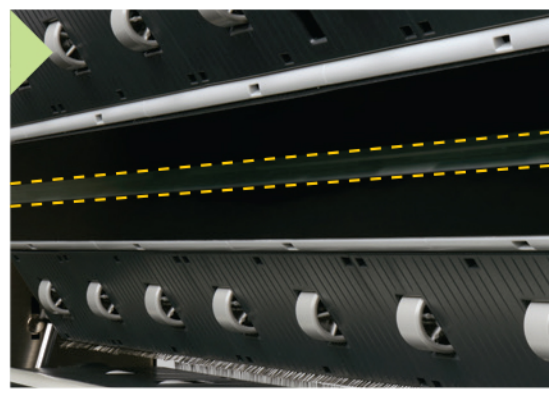

SMARTWORKS IMAGING LINK

Reduce body and hand-eye movement with this tablet app that brings the full power of the SmartWorks Imaging software running on the PC right onto the scanner and straight to the fingertips of the tablet user.



SmartLF SGi

IDEAL FOR THESE DOCUMENT TYPES

- ▶ THICK MEDIA
- ▶ TECHNICAL
- ▶ MAPS
- ▶ ARTWORK
- ▶ PHOTOS

Great color, high volume
– for thick documents too

Get the benefit of CCD technology without the cost. SmartLF SGi thick-media scanners deliver full high-definition. You'll capture color with realism and accuracy – on originals up to 15 mm thick. The higher focal length of this series means it can also cope with originals that have raised surface detail. Instant-on also saves time and energy.

- Perfect for any type of document
- Realistic color and excellent size accuracy
- Accepts thick media up to 15 mm
- Designed for high volume
- Low maintenance
- SmartWorks TOUCH software is included
- For optional software choose from:
 - SmartWorks Imaging – new with remote control app for tablets (tablet not included)
 - SmartWorks Pro – support for older scanners
- Basic floor stand, PC mount kit and repro stand options



SENSOR	SCAN SIZE	OPTICAL DPI	MAX DPI	INSTANT ON	PAPER LOAD	REMOTE SOFTWARE CONTROL	THICK MEDIA
CCD	36" 44"	1200	9600	Yes	Down	Yes	Yes

SmartLF Scan!

IDEAL FOR THESE DOCUMENT TYPES

TECHNICAL

Portable convenience with built-in controller

Finally, a low-cost, large format scanner that works both as a networked office scanner and on the road. Use it on site, in your office or in your home. With 4 ways to move and store digitised information, it couldn't be easier. Store in the scanner; save to a USB stick; or transfer to a standalone or networked PC.

- Small, light, large format scanner with a sturdy, wheeled carrying case
- Control everything from the scanner – no PC required
- Scans documents from A4 up to A0/36" wide
- Scans in full color, greyscale or black & white
- 600 dpi optical resolution; 600 dpi max. scanning resolution
- Save to PDF, JPG or TIFF
- Maximum scan length 200"
- Scan to USB, internal memory, PC or network
- Windows PC app to collect scans over network
- Market-leading images at low cost



SENSOR	SCAN SIZE	OPTICAL DPI	MAX DPI	INSTANT ON	PAPER LOAD	COMPUTER	PORTABLE CASE
Single Sensor™	24" 36"	600	600	Yes	Up	Optional	Yes

SOFTWARE YOU CAN COUNT ON

Choose from 3 types of intuitive software systems. 1 is free, and 2 are optional upgrades with even more features. All help you get up and running quickly. And dependably.



SmartWorks IMAGING

This newest member of the SmartWorks software family is a fresh implementation of the scan-once workflow trusted and appreciated by so many SmartWorks Pro users.

Optimized all the way through, SmartWorks Imaging is clearer and easier to navigate than

SmartWorks Pro. A faster performance with revised preset control, better printer drivers and a new multi-page thumbnail pop-out feature make SmartWorks Imaging the perfect productivity partner for SmartLF SCi and SmartLF SGi large format scanners.

SmartWorks TOUCH

Free with all SmartLF SCi and SmartLF SGi scanners, SmartWorks Touch is the easiest way to manage scanning, copying, emailing and printing. Use with a touchscreen, regular mouse and keyboard or a combination of the two. It's up to you.



SmartWorks Touch has an efficient single screen interface that groups all controls and scanner information

- 1 This is the normal starting point where a scan file name and location are set up and a preset selected that most closely describes the original to be scanned.

To copy, simply change the output from file to printer, decide if preview is needed, then click the green button.

- 2 Large fast-fix icons for quick and easy selection of basic editing functions. Use this area to fix orientation, removal of unwanted edge information and correct reversed images.

- 3 A monitoring area appears when scanning in multi-page and during copying (collation).

- 4 The last scan can be enhanced in the adjustments panel using tools like sharpen, black and white point and many others.

Changes can be applied once, carried forward to the next scan or even saved as a new preset.

Unsaved changes can be rolled back using the history drop-down or by using the resets.

- 5 Navigate easily around in your image. Zoom in and out and back to full image view in a second.

SmartWorks PRO

SmartWorks Pro allows users to rapidly discover the scan-once workflow and many other useful features available in this advanced scanning application. Designed for productivity, SmartWorks Pro provides selection and creation of unique presets as well as the freedom to reprint, re-open and reformat scan files.



SmartWorks Pro is designed for productivity and for the perfectionist - the power is in the detail

SmartWorks IMAGING LINK

This tablet app moves control of scanning with SmartWorks Imaging right onto the scanner. Useful for increasing productivity, reducing body and hand-eye movement and for users just getting started with scanning, the app brings the full power of the software running on the PC straight to the fingertips of the tablet user.

Tablet not included.



ACCESSORIES

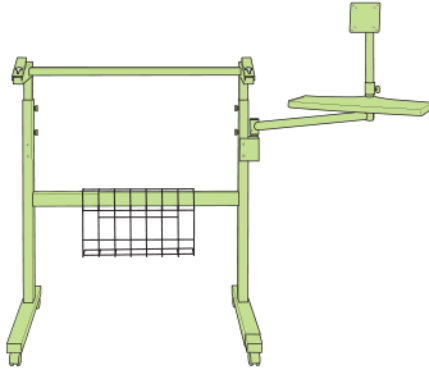

REPRO STAND

Place your Colortrac scanner above most popular large format printers to create a practical, high-productivity workstation. (Compatible with most printers from HP, Canon, Epson and others.)

The repro stand holds the scanner, PC, flat screen and keyboard to minimise the combined scanner/printer footprint. Scanner height has 4 adjustable settings:

- 45 inches/1143 mm
- 43 inches/1093 mm
- 40.8 inches/1038 mm
- 39 inches/988 mm

PC/SCREEN MOUNT KIT

Combine your computer, LCD flat screen and scanner into a self-contained, movable scan processing station by mounting this kit onto the Colortrac floor stand.

Fits any standard large PC cabinet and full-size keyboard.

Note: Scanner, PC, LCD flat screen, keyboard and mouse are not included

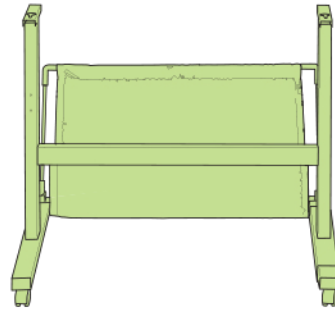

FLOOR STAND

Minimise the installed footprint of your Colortrac scanner and work with documents at a convenient standard height. Sturdy steel stand includes wheels and a removable fabric/aluminium basket to catch documents ejected after scanning.

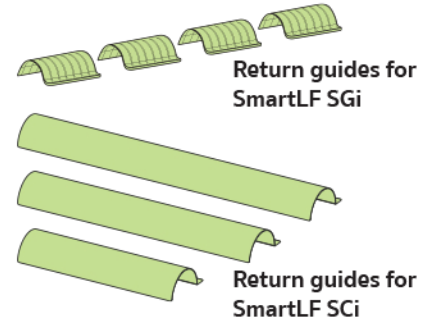

RETURN GUIDES

Return guides save you floor space and time spent rewinding or retrieving documents.

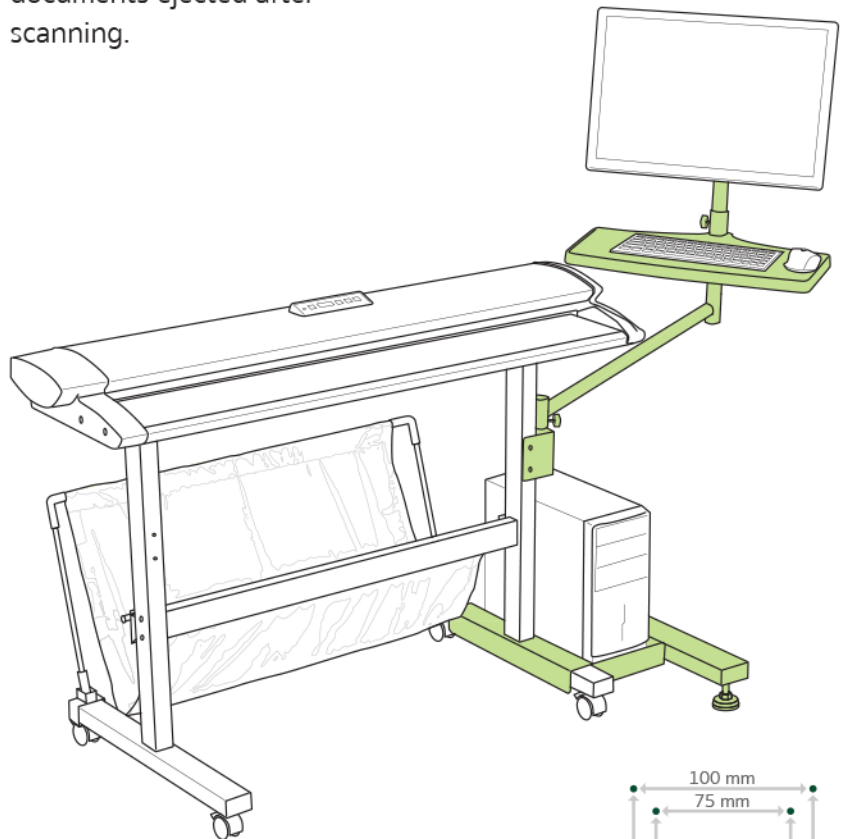

Monitor bracket accepts VESA standard monitors. It has 8 holes arranged in 2 squares: 4 holes at 75 mm and 4 holes at 100 mm measured horizontally and vertically between the centres.

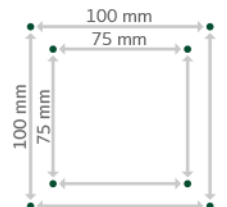

SmartLF scanners

QUICK GUIDE



	SmartLF SCi 36"		SmartLF SCi 42"		SmartLF SGI 36"		SmartLF SGI 44"		SmartLF Scan!	
	SCi 36c	SCi 36e	SCi 42c	SCi 42e	SGi 36c	SGi 36e	SGi 44c	SGi 44e	Scan! 24	Scan! 36
SmartLF SCi and SmartLF SGI scanners are also available in monochrome (m) versions										
Scan width	36 inches (914 mm)		42 inches (1067 mm)		36 inches (914 mm)		44 inches (1118 mm)		24 inches (607 mm)	36 inches (914 mm)
Maximum document width	38 inches (965 mm)		44 inches (1118 mm)		38 inches (965 mm)		46 inches (1168 mm)		26 inches (660 mm)	38 inches (965 mm)
Color speed	6 in/sec (152 mm/sec)	12 in/sec (305 mm/sec)	6 in/sec (152 mm/sec)	12 in/sec (305 mm/sec)	4 in/sec (102 mm/sec)	8 in/sec (203 mm/sec)	4 in/sec (102 mm/sec)	8 in/sec (203 mm/sec)	3 in/sec (76 mm/sec)	
Mono speed	13 in/sec (330 mm/sec)				13 in/sec (330 mm/sec)				4.5 in/sec (114 mm/sec)	
Maximum media thickness	0.08 inches (2 mm)				0.08 inches (2 mm) for flexible documents 0.59 inches (15 mm) for thick media				0.02 inches (0.5 mm)	
Accuracy	+/-0.1% +/-1 pixel				+/-0.1% +/-1 pixel				0.2% +/-1 pixel	
Sensor technology	SingleSensor™				6 x CCD				SingleSensor™	
Face-up scan	Yes				No				Yes	
Optical resolution	1200 dpi				1200 dpi				600 dpi	
Windows PC required	Yes				Yes				Optional	
Stand options	Yes				Yes				No	
Portable	No				No				Yes	
Carry case	No				No				Yes	
Dimensions (WxHxD)	45.1x6.0x15 inches (1150x152x381 mm)		51.2x6.0x15 inches (1300x152x381 mm)		56x8x18 inches (1430x210x450 mm)				34.3x5x6.3 inches (870x126x160 mm)	46.3x5x6.3 inches (1175x126x160 mm)
Weight	53 lbs (24 kg)		58.4 lbs (26.5 kg)		112 lbs (51 kg)				11.5 lbs (5.2 kg)	15.4 lbs (7 kg)



colortrac.com/smartlfsci

colortrac.com/smartlfsgi

colortrac.com/smartlfscan

ABOUT COLORTRAC

Founded in 1989, Colortrac started by developing large format scanning solutions and quickly earned a reputation for value that led to the company winning the coveted Queen's Awards for enterprise and export. Today, we serve the entire large format document scanning market with a portfolio of no-nonsense scanning solutions. Colortrac has more than 80 distributors in over 90 countries and is also an OEM supplier. We are dedicated to making scanners that get the job done to high standards at a competitive price. That's why so many industries Count on Colortrac.

colortrac.com

Colortrac is a Global Scanning UK Ltd brand. Colortrac makes no warranty of any kind with respect to the information contained in this document and reserves the right to change specifications without notice. Colortrac and SmartLF* are trademarks of Colortrac. All other trademarks are the property of their respective owners.

Colortrac HQ & EMEA: Global Scanning UK Ltd., St Ives, UK, +44 1480 464618
Colortrac Americas: Global Scanning Americas (VA) Inc., Chantilly, VA, USA, +1 703 717 5631
Colortrac Japan & Asia: Global Scanning Japan A/S, Yokohama-Shi, Japan, +81 45 548 6991